

# Minor 12

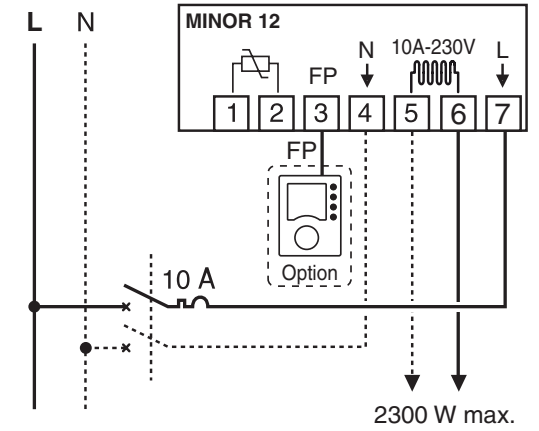

2004/108/CE  
2006/95/CE

www.deltadore.com

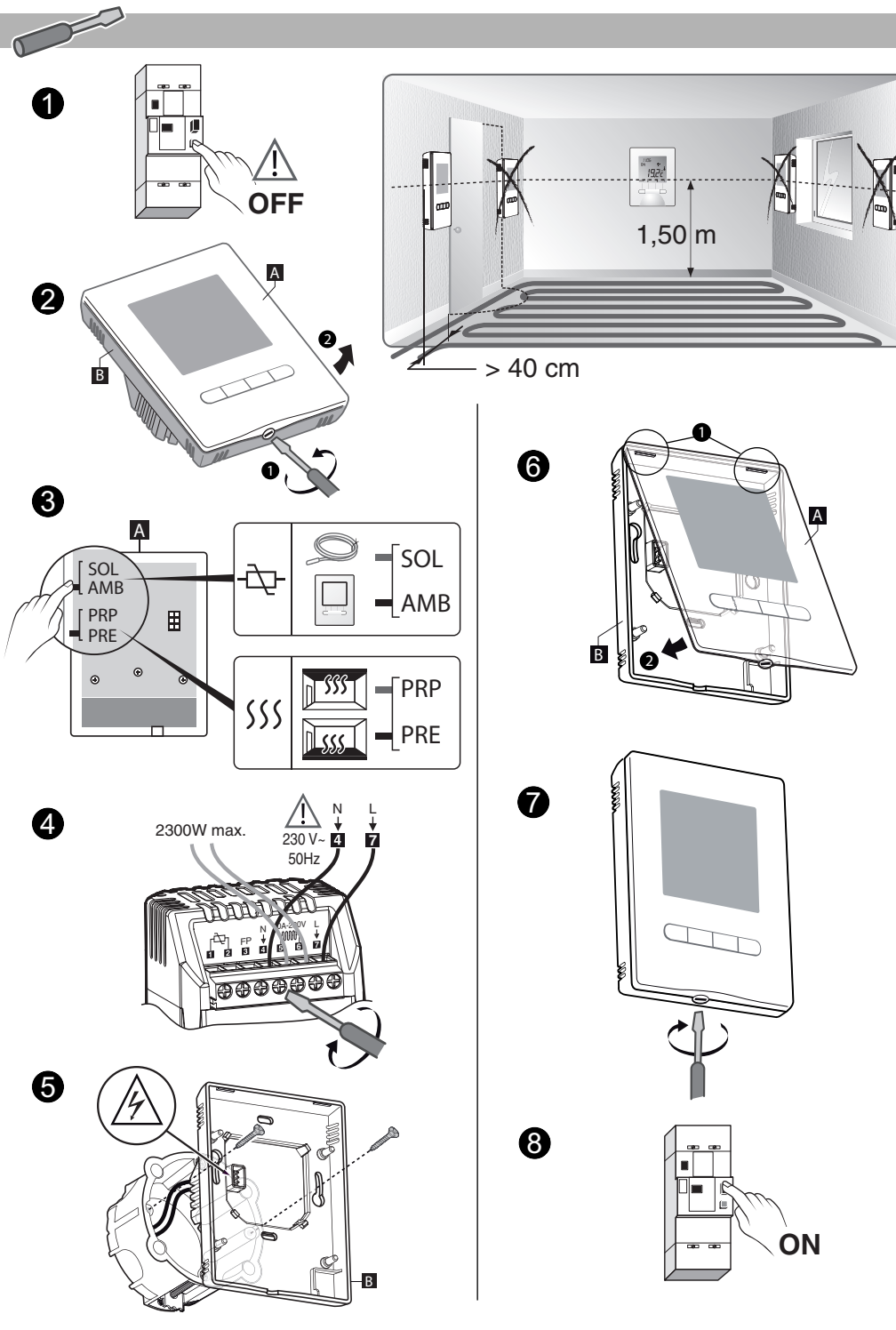

2300 W → +

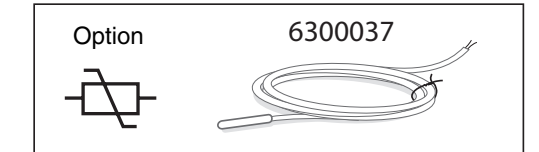
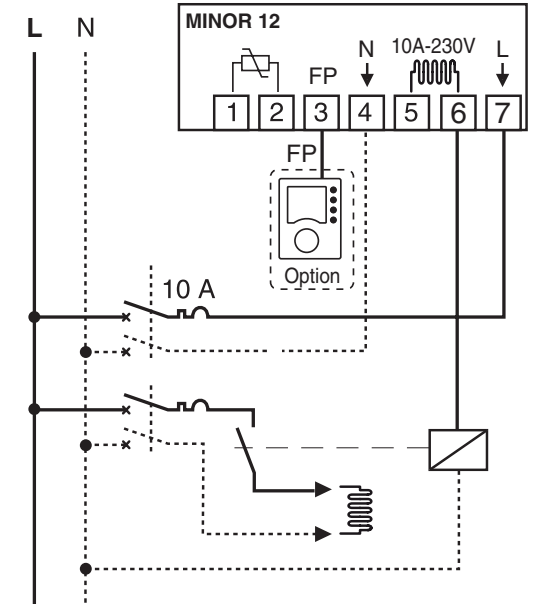



## CF01 Choix d'affichage / Choice of display mode

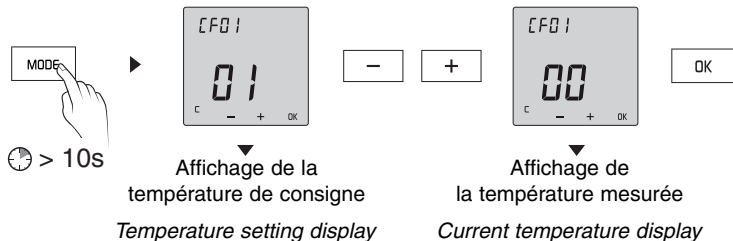

## CF02 Correction de la température mesurée / Adjustment of the current temperature

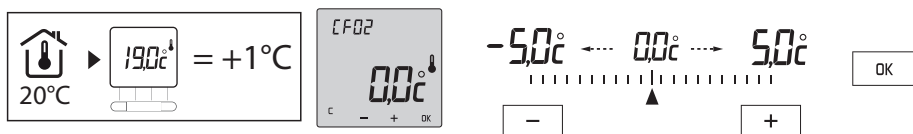

## CF03 /



## CF04 Mise en chauffe progressive / Gradual heating

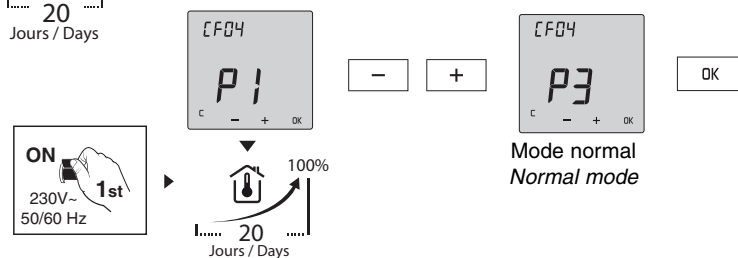

## CF05 Puissance à piloter / Power to be controlled

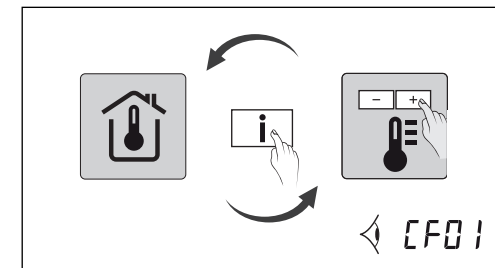
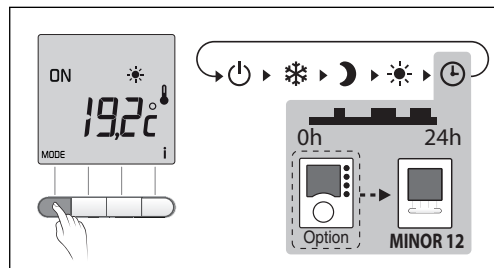
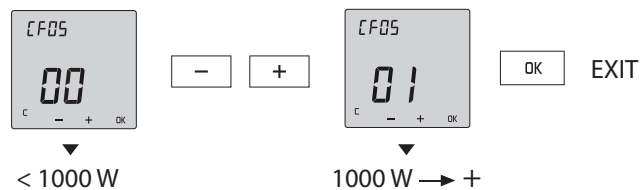

## Paramètres par défaut Default settings

	20°C		5°C ↔ 30°C
	PRE 18°C	PRP 17°C	5°C ↔ 30°C
	7°C	8°C	5°C ↔ 15°C

## / CF03

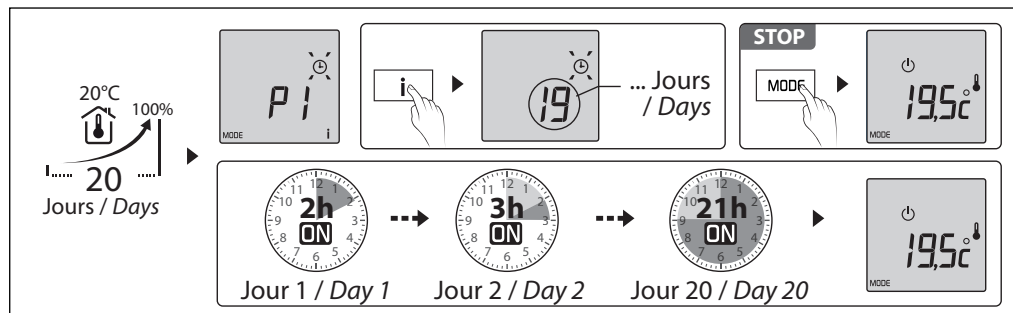
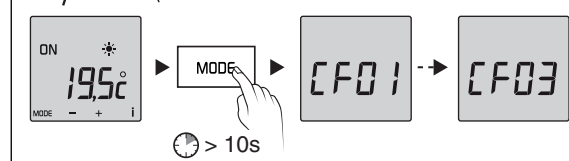

## Réglage température de consigne avec sonde de sol / Temperature setting for underfloor sensor

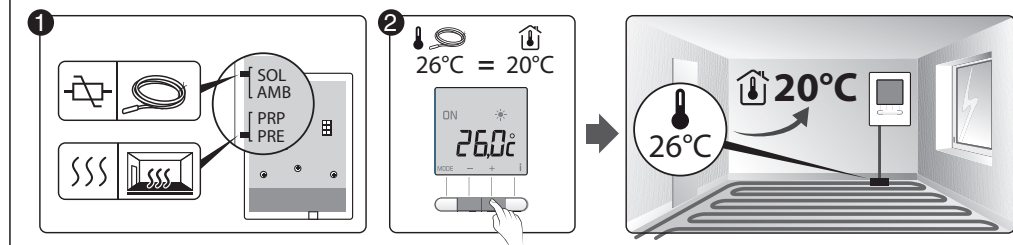

	230 V~, 50/60 Hz 12 VA
	10A max. 230V
°C	-5°C / +40°C
	Classe II / Class II
	104 x 80 x 48 mm

	2004/108/CE - 2006/95/CE	
	CA : 0,8	PRE
Action automatique type 1.C (micro-interruption) 1.C automatic action (brownout)		
Installation en milieu normalement pollué Install in an environment with normal pollution levels		